



G6N

BOLLARDS
Automatic retractable
Semi-automatic

CAME 
URBACO

URBACO.CAME.COM

ACCESS CONTROL
VEHICULAR

SECURING
RETRACTABLE BOLLARDS

ACCESS CONTROL AND SECURITY SOLUTIONS FOR TERTIARY AND URBAN

CAME 
URBACO

Pedestrianisation and the safety of the population are at the heart of the challenges facing cities. Urban life is influenced by these installations which control the traffic flow in order to protect and reassure citizens.

CAME URBACO solutions fit perfectly into urban and tertiary areas thanks to their adaptability and thus contribute to an indispensable security dimension. They provide perimeter security and access control for urban and business areas.

Inventor of the retractable bollard, CAME URBACO puts its skills at the service of integrated access control systems, perimeter security, urban design and automated traffic flow control using retractable, removable and fixed bollards.

The leading brand designs, manufactures, maintains and sells technological solutions to share and delimit pedestrian areas but also to protect sensitive sites where the need for security of buildings and people is crucial.



SUPPORT IN PROJECT MODE





CAME has a team of experts who study the stakes of each project in order to propose and develop tailor-made solutions, which match perfectly with the identified particularities.



A nighttime photograph of a city street. In the foreground, there are several retractable bollards connected by a chain, with light trails from passing vehicles. In the background, there are tall palm trees and a grand, ornate building with many lit windows. Street lamps are also visible, casting a warm glow.

CAME URBACO







PRECURSOR OF INNOVATIVE ACTIONS

-  Inventor of the retractable bollard
-  1st operator to design a centralized technical management system for pedestrian areas in the world
-  1st French manufacturer of High security bollards certified according to the latest international standards.
-  1st producer in the world to have executed 2 crash tests on the same bollard
-  A multitude of tailor-made projects for installations all over the world

NEW ADVANTAGES

- + Improved bollard head stability: No more adjustments required | constant stability**
With a new system, centering the bollard head is simply done and stabilizes by itself over time.
- + Only one casing: Makes installation and maintenance easy**
The casing, the same for all kind of motorization, no longer undergoes any modification before assembly, which ensures quality consistency, enhance the easiness of assembling and maintenance. The opening and the fixing holes needed to the installation of the different supports are standardised.
- + A common movable quick connector: Simplified maintenance**
All main electrical connections are brought to a quick connector with common power supply. The cables routing is then simplified and common to all types of “motorization” and maintenance of all is greatly improved. This quick connector is installed on a support that can be easily removed out of the casing.
- + Common and interchangeable supports for accessories: Optimized handling**
Whatever the motorization is, all the supports keep the same assembly logic inside the casing.
- + LED strip and luminous ring improvement: Better light signage & strength**
The new design of the light ring improves the bollard aesthetic, allows a better brightness, a better sleeve fixation and impermeability and also allows quick LED strip replacement.
- + Design preserved by a specific seal: Long-term aesthetic**
The brush seal prevents dust from entering inside the casing and thus reduces the risk of scratches on the sleeves. It gets easily replaced in case of wear over the time.

ITS STRENGTHS

-  Customizable and interchangeable sleeve
-  Quick and economical maintenance
-  Impact resistance: 1,5T from 32 to 48km/h*
-  A new optimized version
-  An historical bollard that has proved his worth
-  ISO EN 124 – E600

MONOBLOC® CONCEPT

Bollard head, casing and cover made of 11mm average thick cast iron material. These parts are cast as one single piece, without any weld nor wear part.

10-YEAR WARRANTY

10-year warranty on cast-iron material bollard head, casing and cover**.



INTERCHANGEABLE SLEEVE CONCEPT (IN OPTION)

An innovative interchangeable sleeve system for customizing the aesthetics of access points and refurbishing any damaged bollard heads in less than 5 minutes.

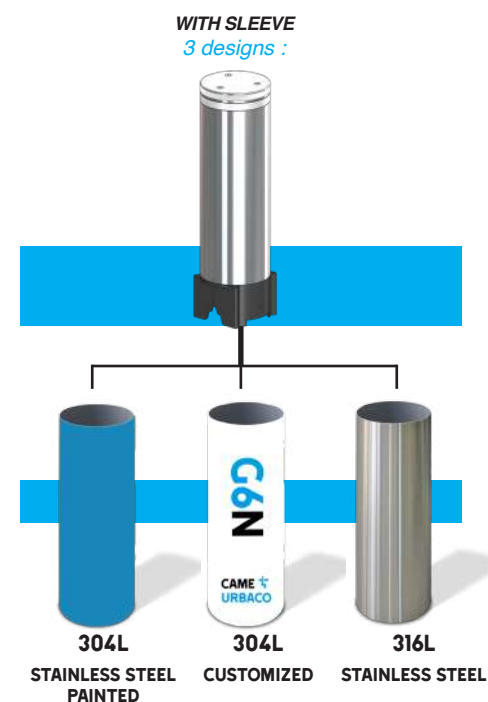

*Equivalence based on mathematical simulation

** See the “Warranty” chapter in our General Terms of Sale

G6N

G6N INNOVATION

Came Urbaco offers an evolution of its G6 historical model. A version combining the legendary reliability of the G6, the innovative customisation of the G6^{EVO} and the strength of the integrated enhancements.

Always attentive to feedback, our Research & Development department has re-examined its flagship bollard in order to propose the following areas for improvement.

Keeping its potential and its assets, today the **G6 New** bollard has new arguments that will be attractive for vehicle access control where the safety issue is moderated.

NEW



Impact resistance equivalent to a **1,5T** vehicle travelling at **32 km/h*** and **2,5 T** at **48 km/h*** (by set of 2 bollards) > **59 kJ** & **133 kJ**

FEATURES

Empty head material	Cast Iron
Treatment	Zinc-based primer as standard reinforcing corrosion-resistance
Sleeve material (For sleeve versions)	304 L Stainless Steel 316 L Stainless Steel
Thickness	11 mm
Bollard diameter	250 mm
Bollard height	550 mm 750 mm
Civil engineering depth (Without drain)	930 mm 1130 mm
Power inside the bollard	24V - 230V
Rising time	5 to 7 seconds
Falling time	5 seconds
Positive safety as standard	Lowering of the bollard in the event of a power failure
IP67	Protected against dust and the effect of immersion

AVAILABLE MOTORIZATIONS



BUILT IN HYDRAULIC PUMP



EXTERNAL HYDRAULIC PUMP



PNEUMATIC

EXISTS IN VERSION



SEMI-AUTOMATIC



TECHNICAL FOCUS FROM G6 TO G6N

CIVIL ENGINEERING CHARACTERISTIC

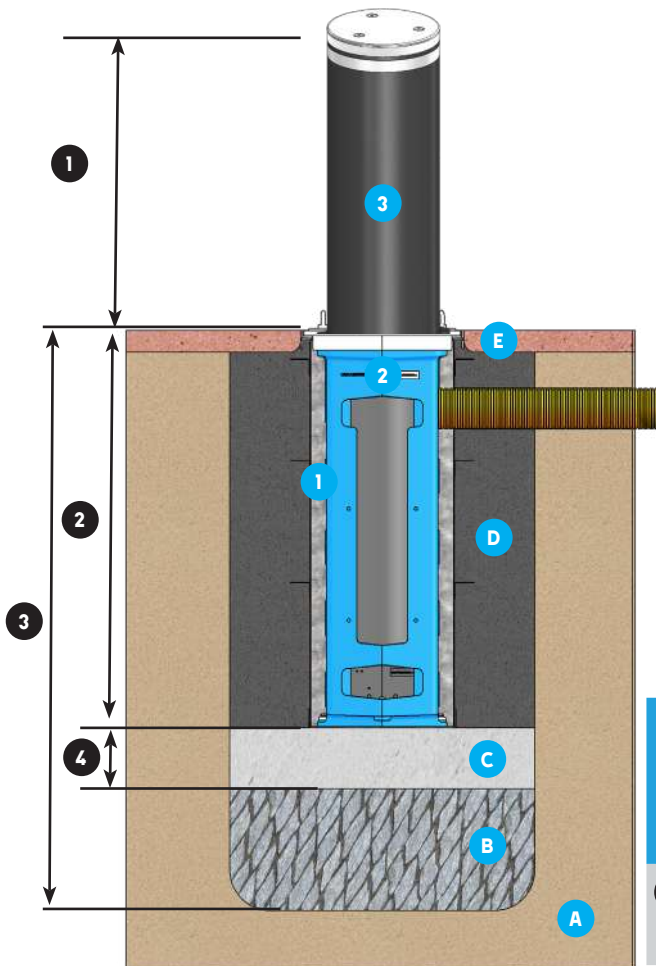

REP	DESIGNATION
MATERIAL	
1	Lost Casing
2	Casing for bollard
3	Bollard's head
CIVIL ENGINEERING	
A	Natural soil
B	Natural Drain covered with geotextile
C	Steel soil
D	Highly dosed concrete
E	Road surface (of your choosing)

Civil engineering data		3	2	Block dimensions (on the ground)	4	Concrete density (Kg/m ³)
		Excavation depth (mm)	Lateral sole (mm)		Steel sole (mm)	
1	Bollard height (mm)	1230	780	810x750	150	350 à 400
		1430	980			

+ LED strip and Luminous ring

The new design of the light ring improves the whole bollard aesthetic, a better sleeve fixation and impermeability and also allows quick LED strip replacement. The latter, placed more towards the outside, assure a better luminosity. Its cable is protected inside the bollard head by a welded tube and the casing by a cable guide chain. Any risk of pinching during the ascent and descent phases is then eliminated.

Luminous ring

Exists in 2 versions

Luminous ring:
(for LED strip)



Simple ring:
(without lighting possible)



+ Replacement of a friction ring by a brush seal

The brush seal limits the dirt from entering and eject them easily. The risk of scratch on the bollard head and customized sleeve is reduced. It gets easily replaced in case of wear over the time.

Cover

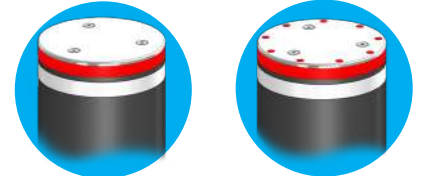

Without Led diffuser

With Led diffusers

Reflective tape

finds its place whatever the head covering.

Finishing

With sleeve



*Bollard head with sleeve
3 designs :*



304L Painted 316L Stainless Steel 304L Personalised Steel

+ Only one casing for all "motorizations"

The casing no longer undergoes any modification before assembly, which ensures quality consistency, enhance the easiness of assembling and maintenance. The opening and the fixing holes needed to the installation of the different supports are standardised.

+ Pneumatic connection

Pneumatic safety assemblies are mounted on a dedicated bracket. A quick coupler and a preformed rigid tube allow for constant positioning inside the bollard as well as considerably improved maintenance access. There is also no longer any risk of the tube being crushed between the head and the casing.

+ Improved bollard head stability

With a new system of spring support (for every control engineering) the bollard head is adjusted almost automatically and is much more stable. The spring perpendicularity is assured and constant. No further adjustments are necessary



+ Quick connector

All main electrical connections are brought to a quick connector with common power supply. The cables routing is then simplified and common to all types of "motorization" and maintenance of all is greatly improved. This quick connector is installed on a support that can be easily removed out of the casing.



+ Common and interchangeable support for accessories

Whatever the motorization is, all the support keep the same assembly logic inside the casing:

- Control engineering support and /or accessories
- Same fixing holes
- Same bracket for limit switches

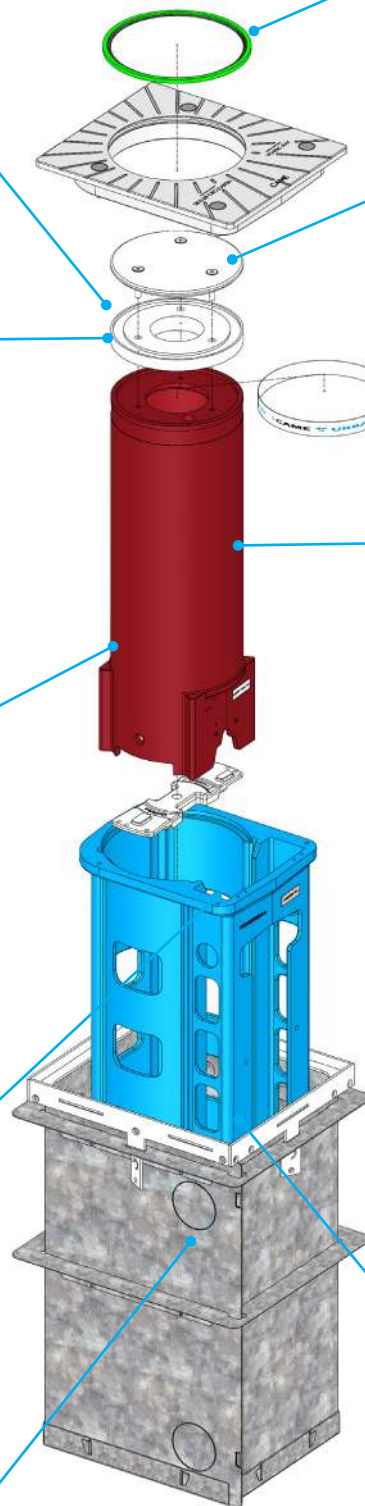
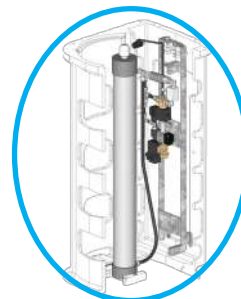



CAME URBACO

CAME URBACO S.A.
457 avenue du Clapier – ZA du Couquiou
84320 Entraigues - FRANCE
Phone + 33 (0)490 48 08 08
urb.communication@came.com

URBACO.CAME.COM

Access control and securing solutions for urban, tertiary, industrial, institutional areas:

- **RETRACTABLE AND FIXED CRASH-TESTED BOLLARDS**
- **ROADBLOCKERS**
- **BOLLARDS MANAGEMENT TOTEM**
- **SUPERVISOR, CENTRALIZED TECHNICAL MANAGEMENT**

Intellectual property of CAME URBACO - Cannot be copied - Non-contractual specifications and images - May be modified without warning - Most models shown are copyrighted. CAME URBACO S.A - S.A. Share capital 1,500,000 € - Business Registration Number 33944567800032 Company Registration Number AVIGNON 1999 B 40308 - TVA Intracom FR 06 339 445 678 - 10/2021 v2.0

